

CaBano

Specs Sheet
Fiche technique

ARONA #33SD32

Square Shower Design – 2 outlets
Système de douche design carré – 2 sorties

 .99 Chrome



#om021

3/4" Thermostatic with 2 way diverter

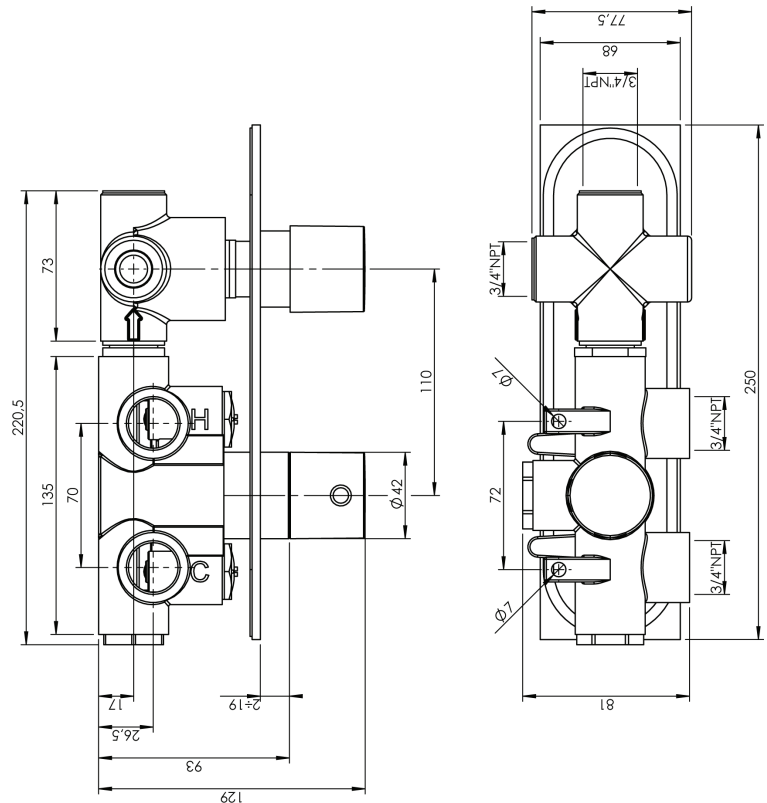

Can add independent flow control
Integrated service stops, filters & back-flow preventers
Rough-in can be mounted horizontally or vertically
12 GPM (45.4 L/min.)



Arona #33021T

Trim for rough-in om021

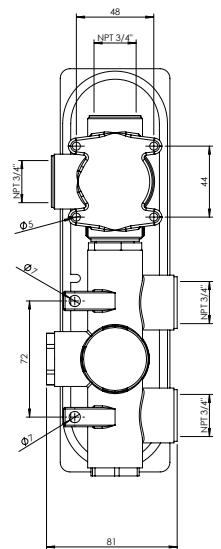
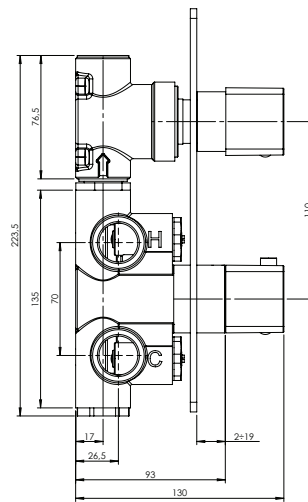
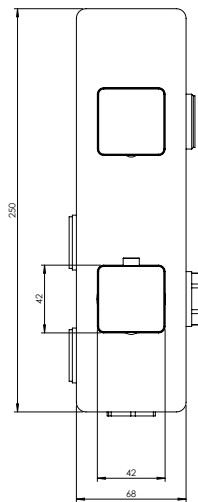

Order om021 rough-in separately
2⁵/₈" x 9⁷/₈"

Finish: Chrome (#99)

#6019

18" shower arm with square flange

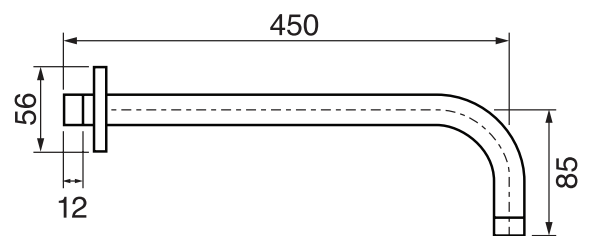

1/2" Male NPT inlet
Sliding flange

Finish: Chrome (#99)

Kuky #6063

Square with rounded corners rain head

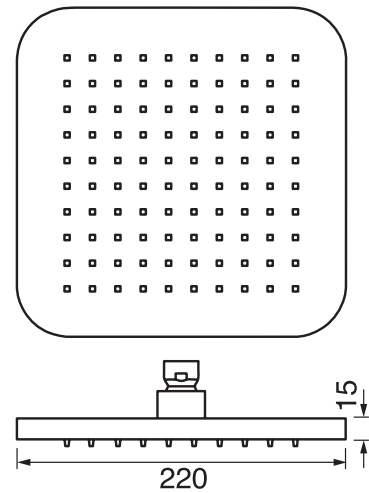

15 mm in thickness
Easy clean nozzles
ABS chrome plated
2.5 GPM (9.5 L/min.)

Finish: Chrome (#99)

#75117

Shower rail kit

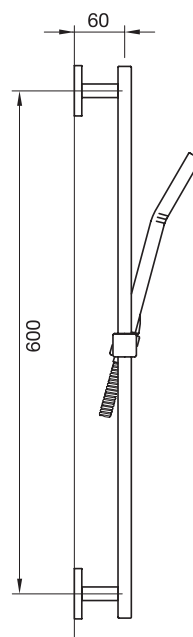

Includes bar, hose and hand shower
Single spray hand shower
Easy clean nozzles
2 GPM (7.5 L/min.)

Finish: Chrome (#99)

Lina #6029

Wall supply elbow

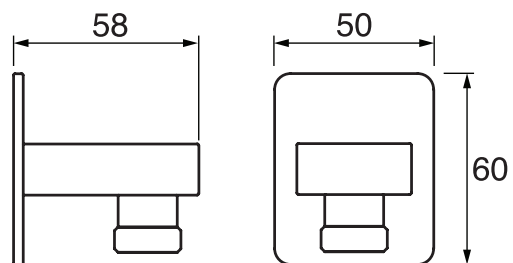

1/2" male NPT inlet
Easy slide installation

Finish: Chrome (#99)