

## Program 1 #89012RT

Trim for rough-in om012

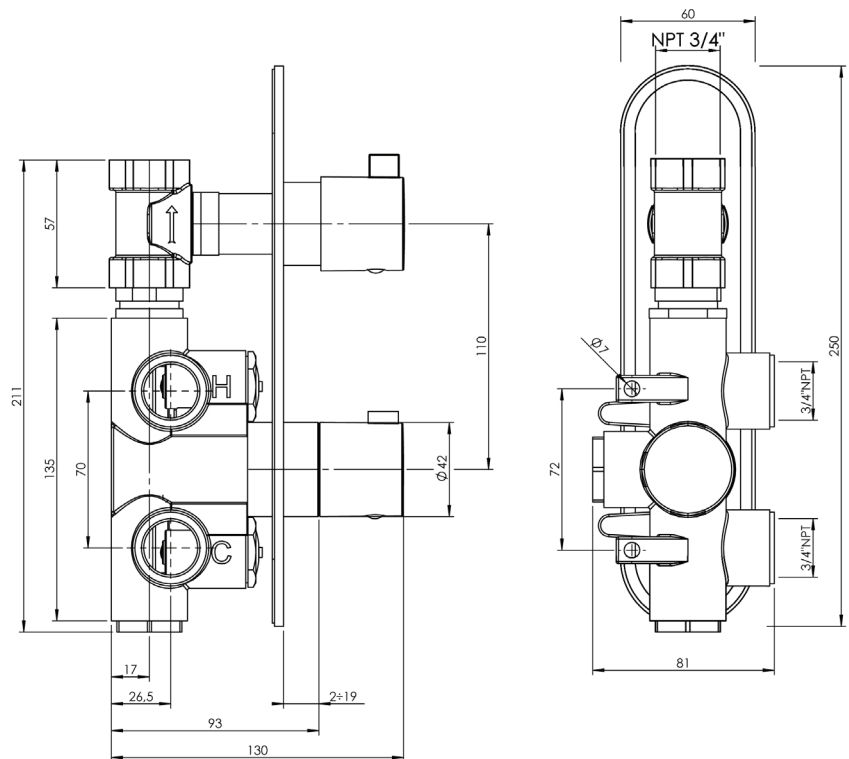

Order om012 rough-in separately  
2<sup>3</sup>/<sub>8</sub>" x 9<sup>7</sup>/<sub>8</sub>"

Finish: Chrome (#99)